

BUILDING MATERIALS ARE SUBJECT TO WEXFORD COUNTY COUNCIL PLANNING COMPLIANCE

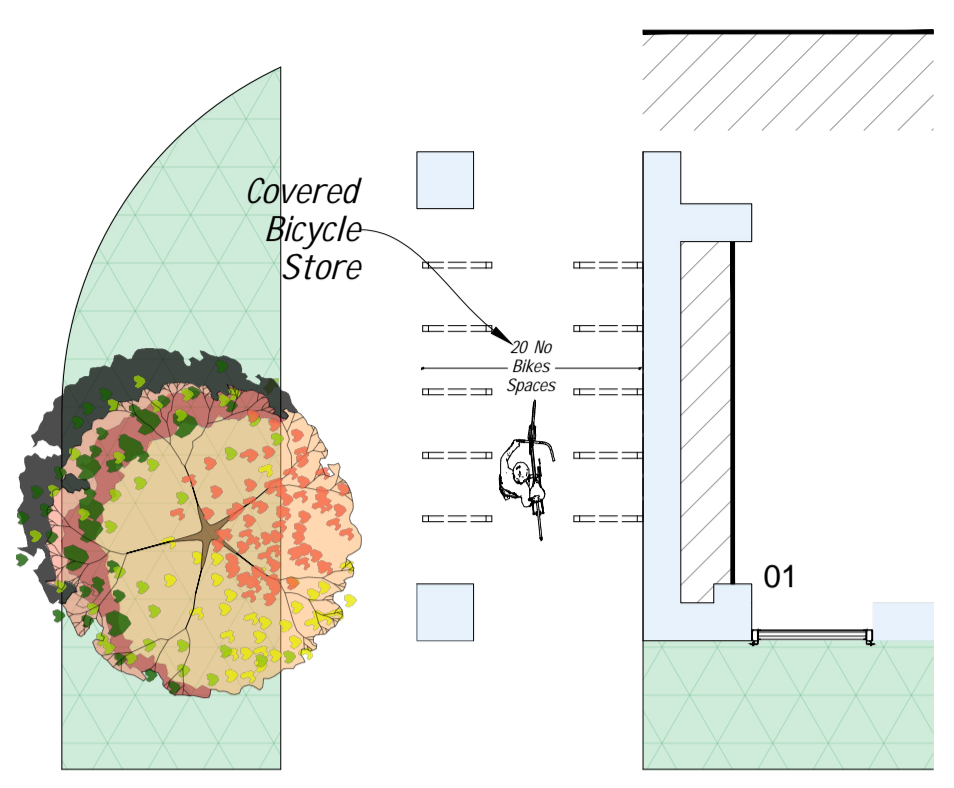

**50** **pittman** traffic & safety equipment  
 Product Specification Sheet  
 Product name - Velo Up Regular Two Tier Bicycle Storage  
 Product code - P- 725714

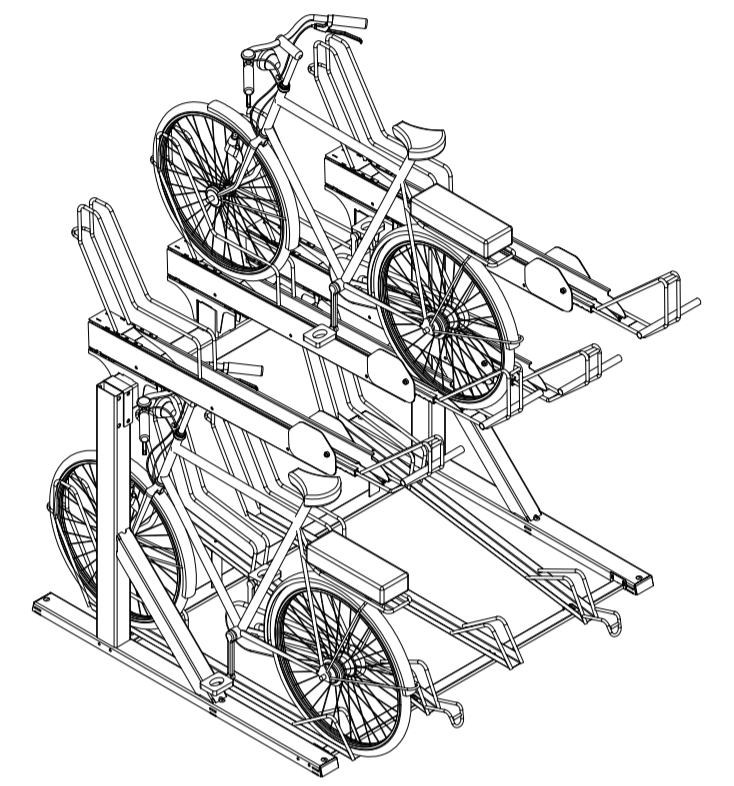
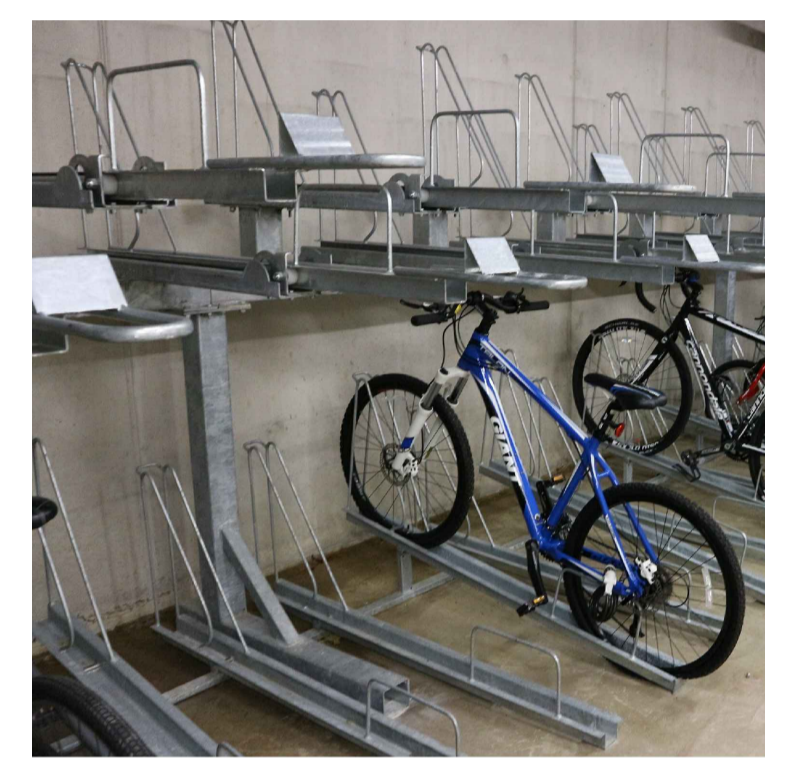

Velo Up Regular Two Tier Bike Storage

## Middle Avenue Apartments (MAB) 258-369

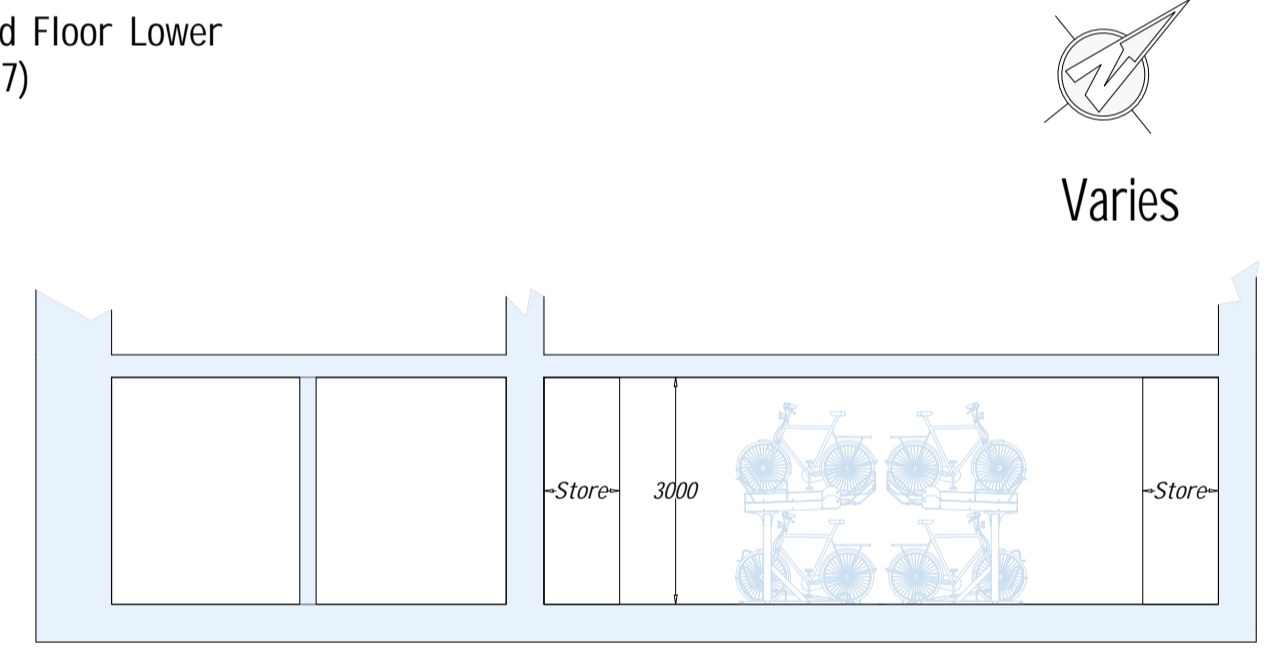
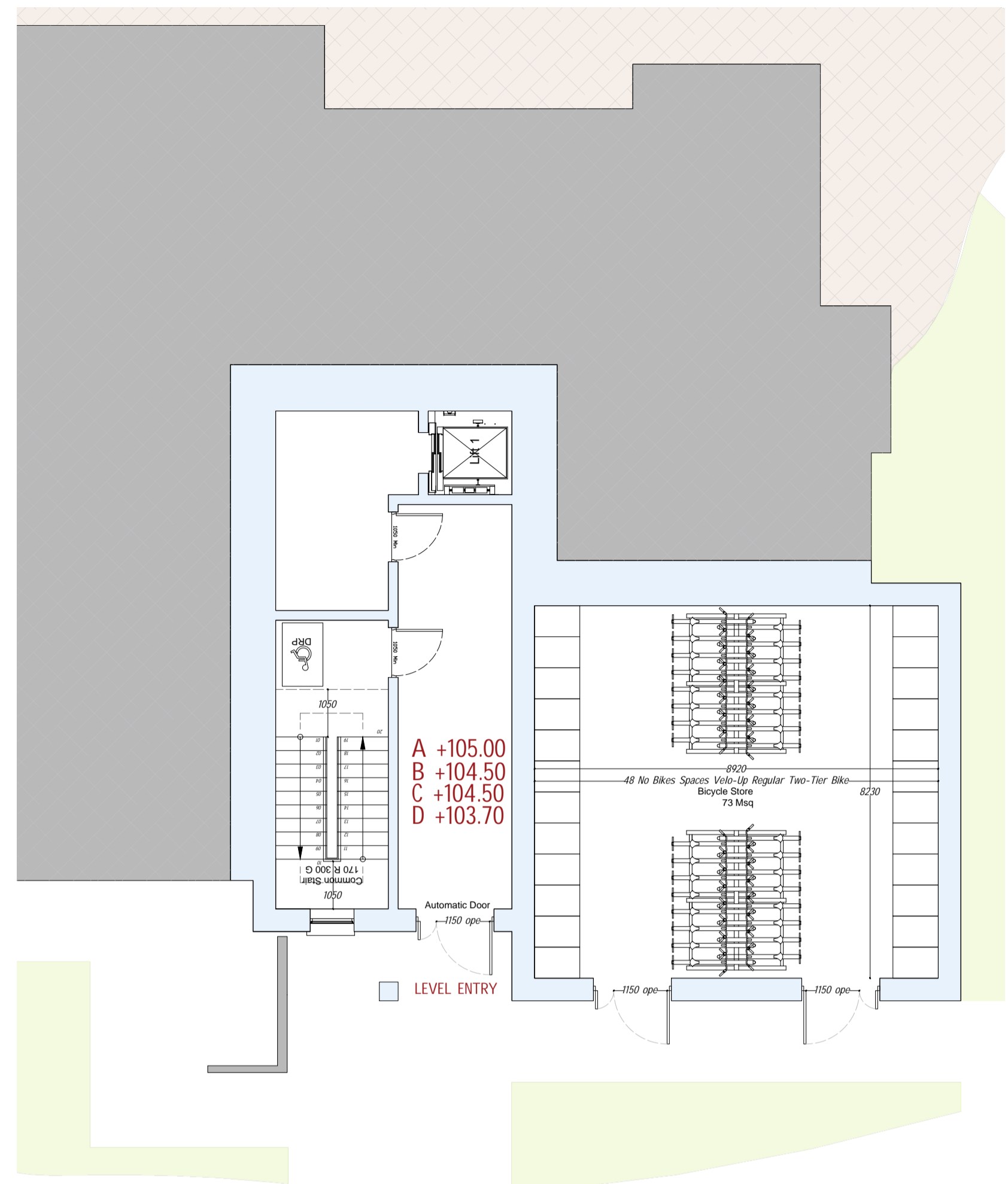
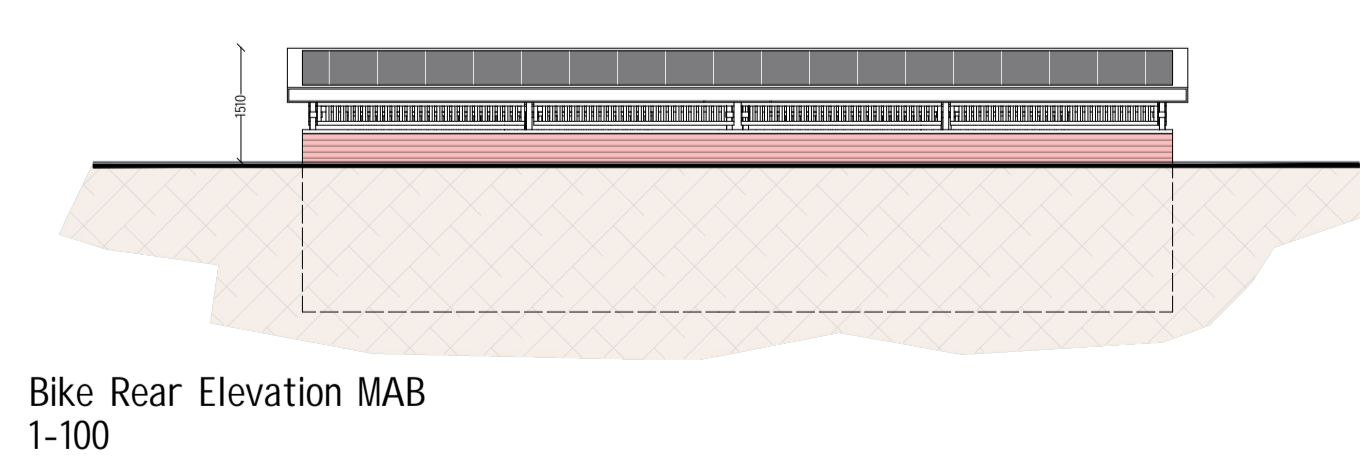
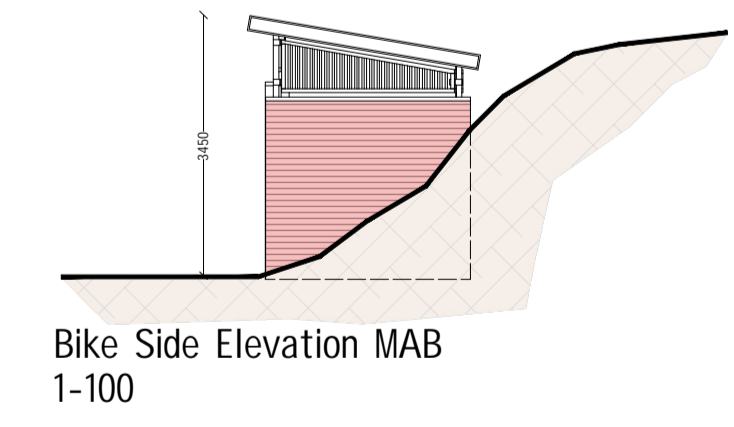
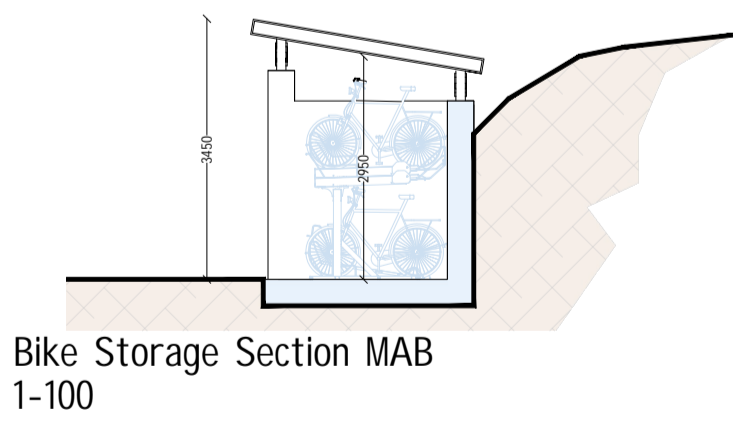
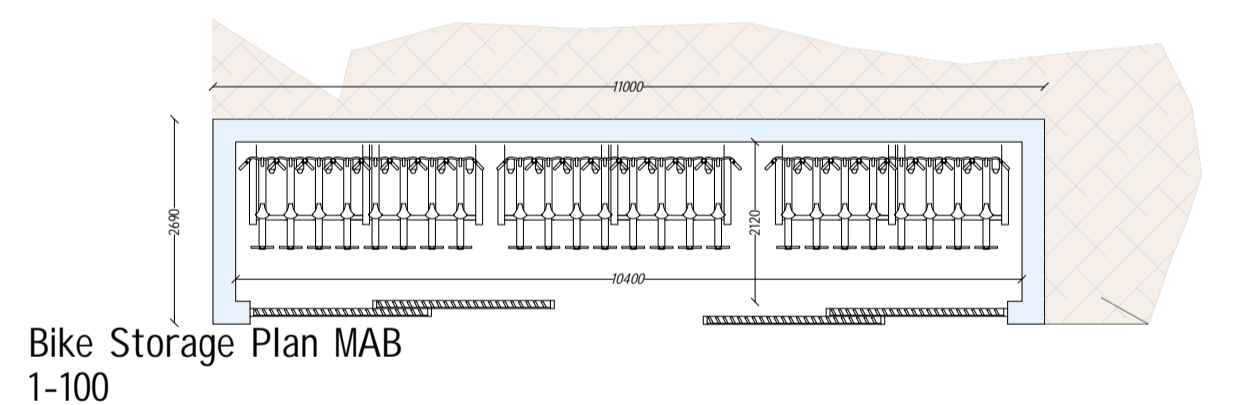

## Lower Avenue Apartments (LAB) 152-247

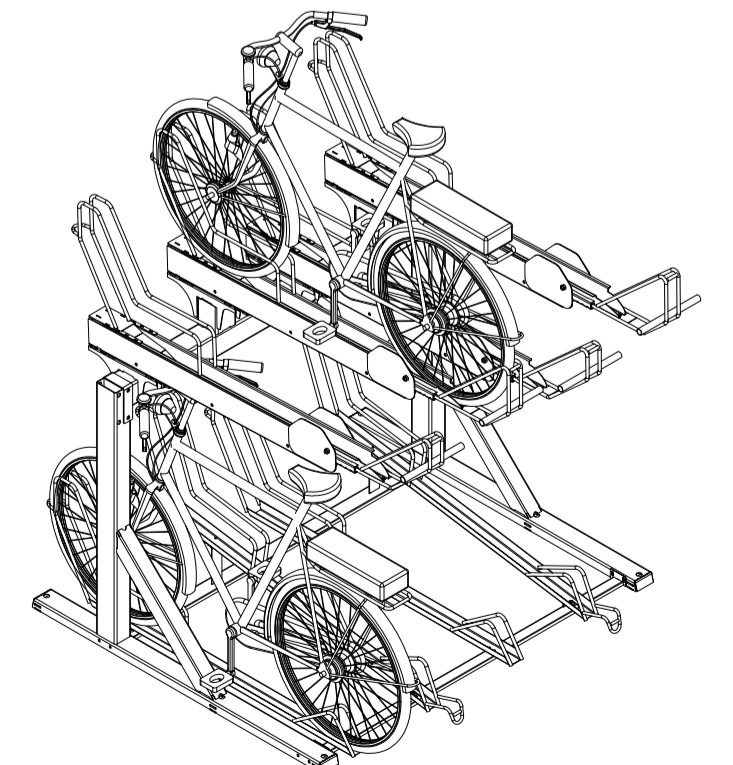
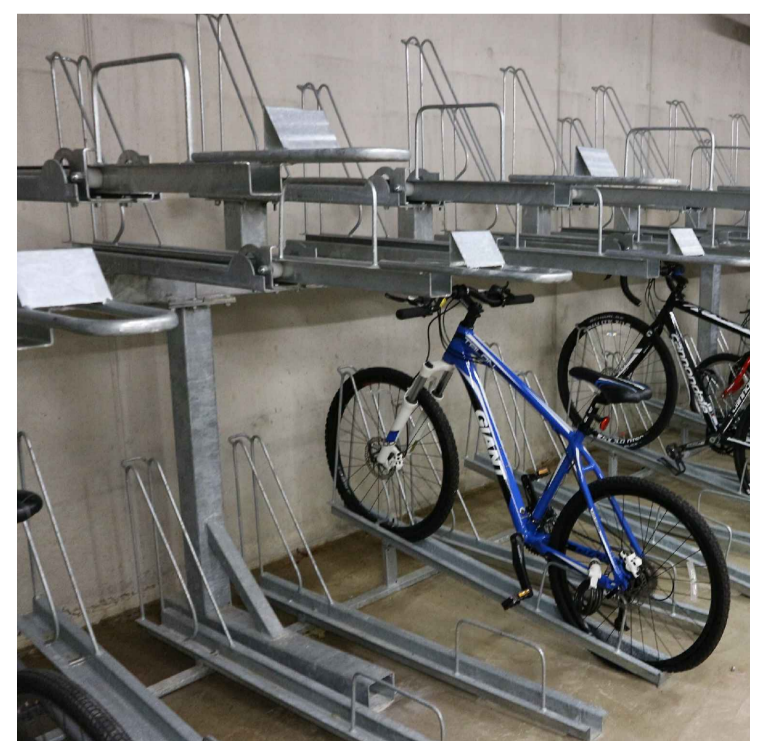

Velo Up Regular Two Tier Bike Storage

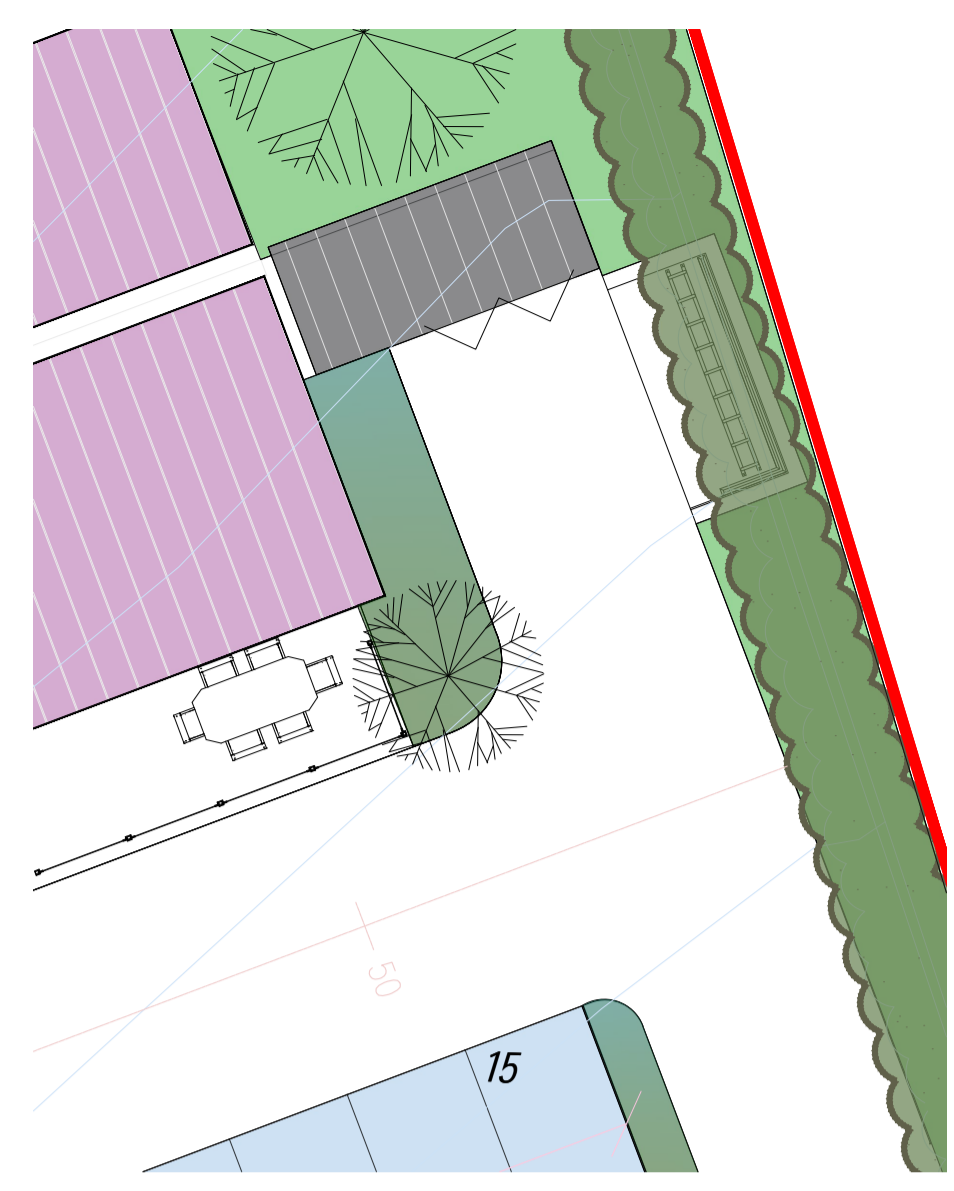

Entry Apartments (EAB) 1-10  
 Site Location 1/200

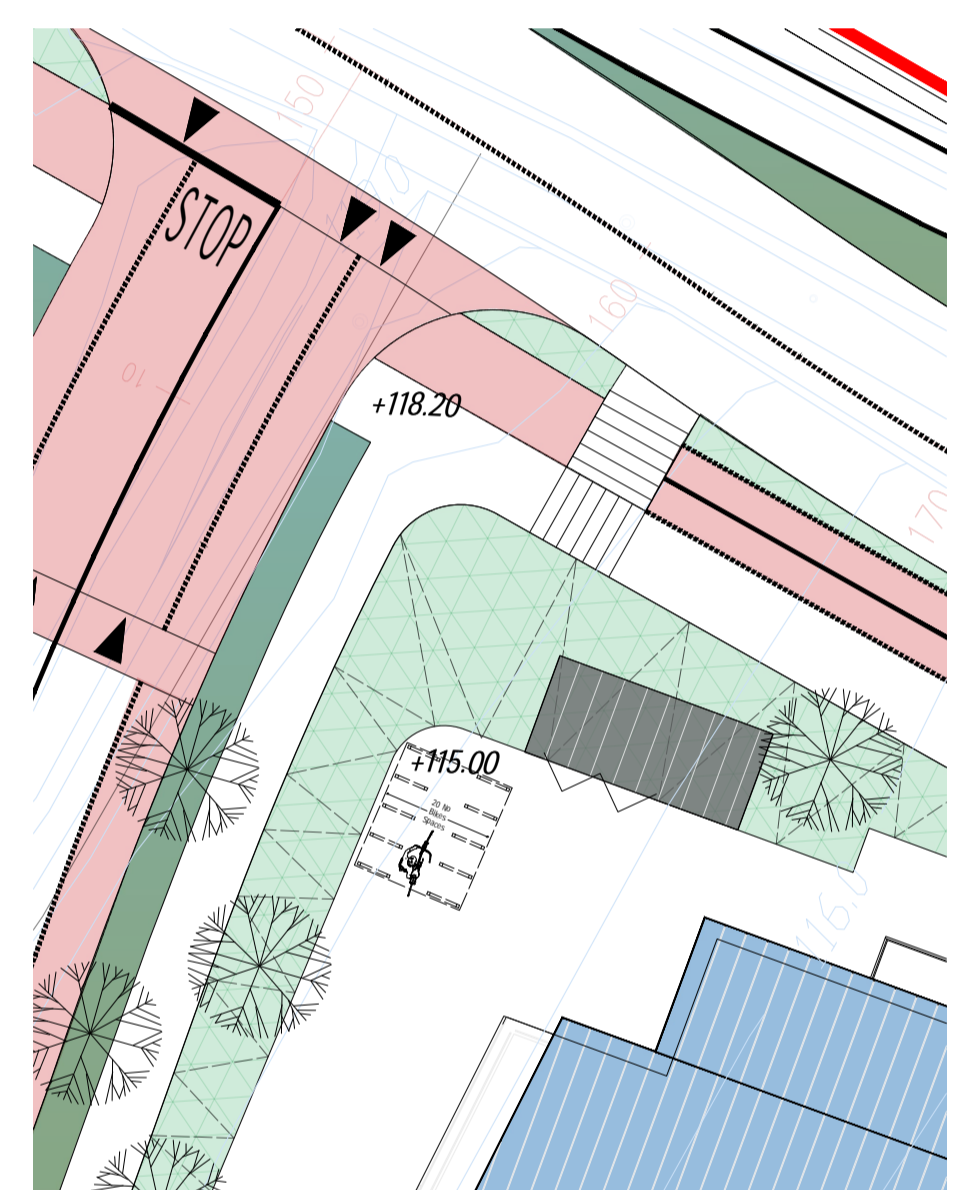

Exit Apartments (XAB) 248-257  
 Site Location 1/200

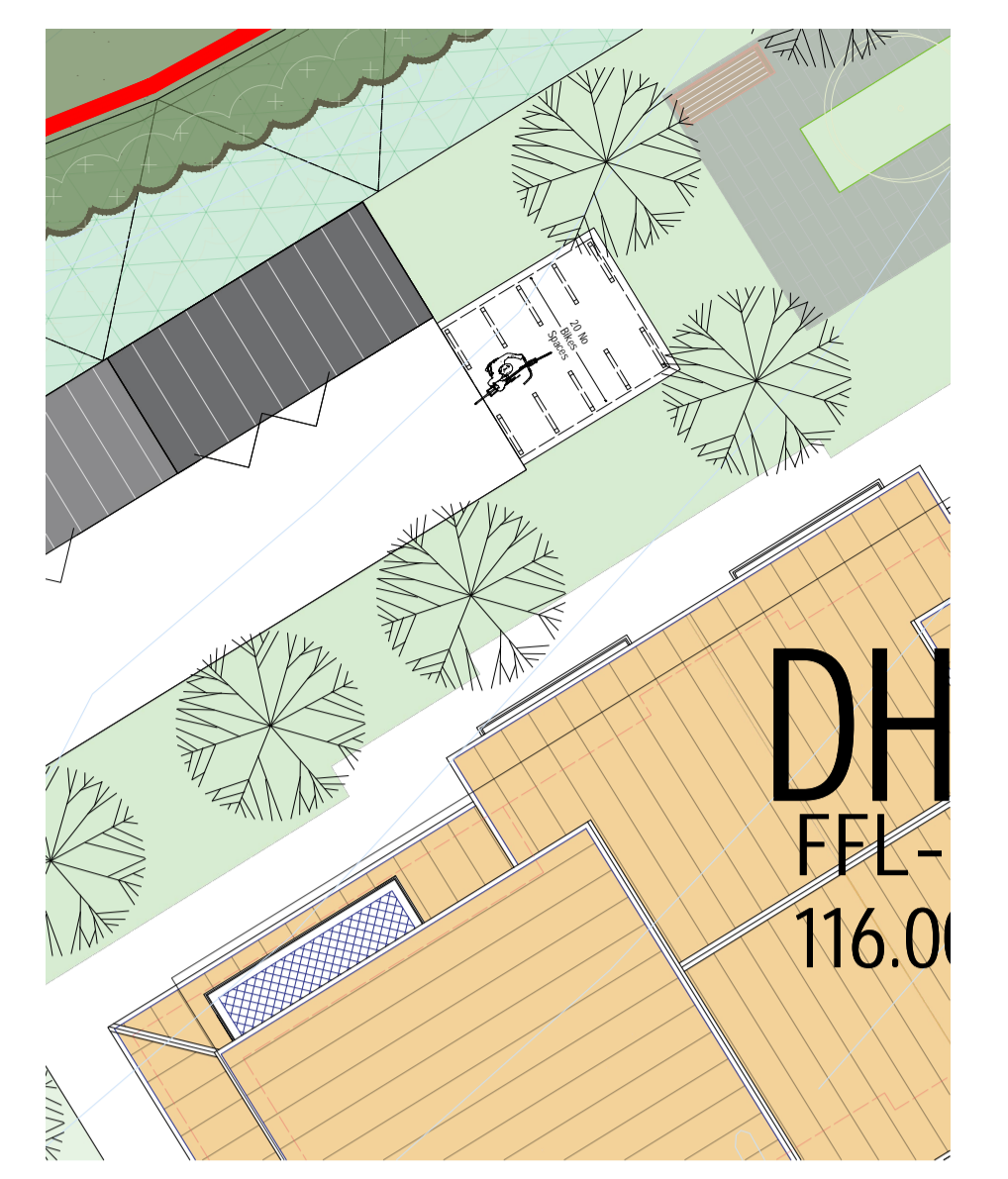

Duplex Block (DHB) 40-47  
 Site Location 1/200

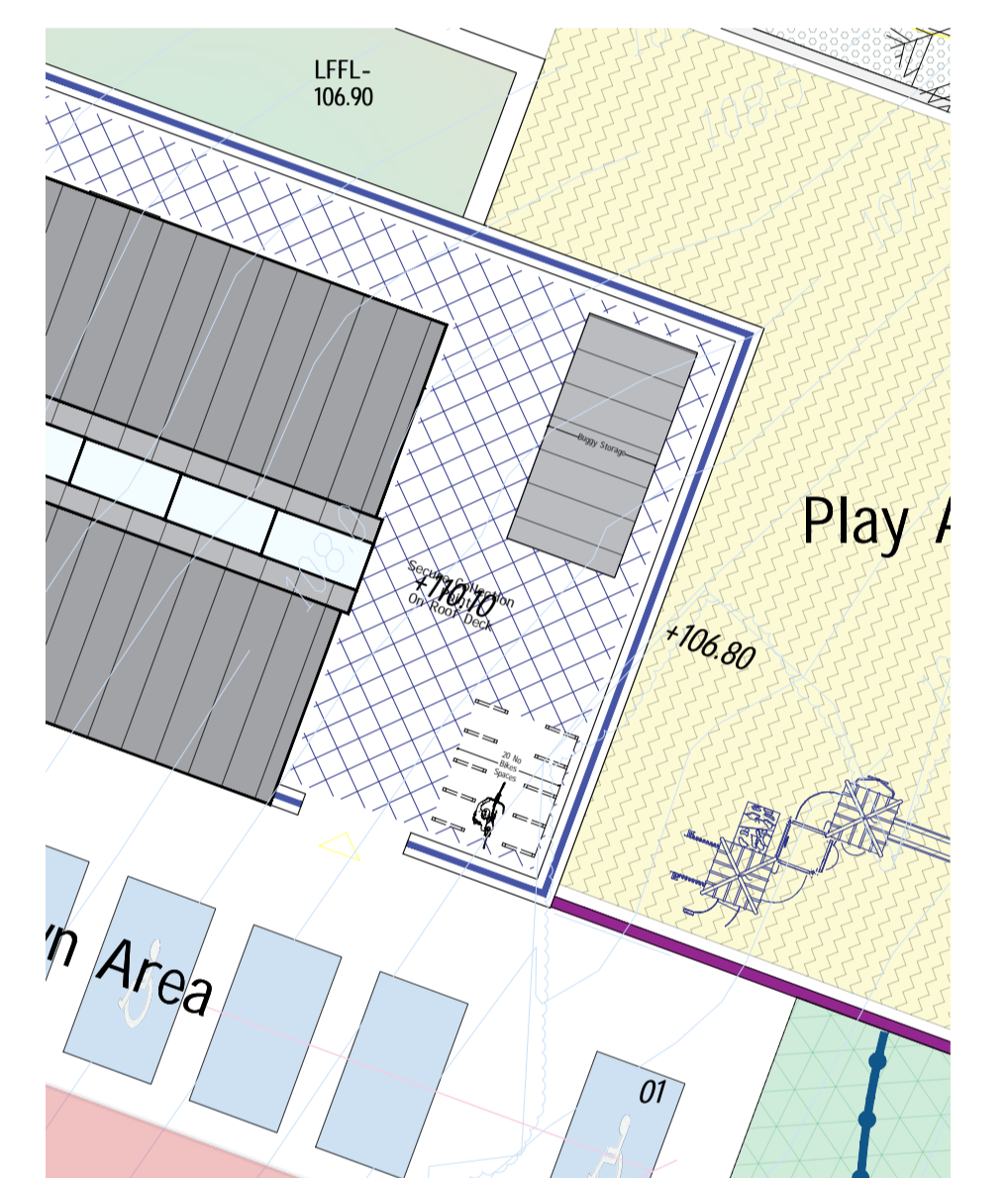

Childcare Building  
 Site Location 1/200

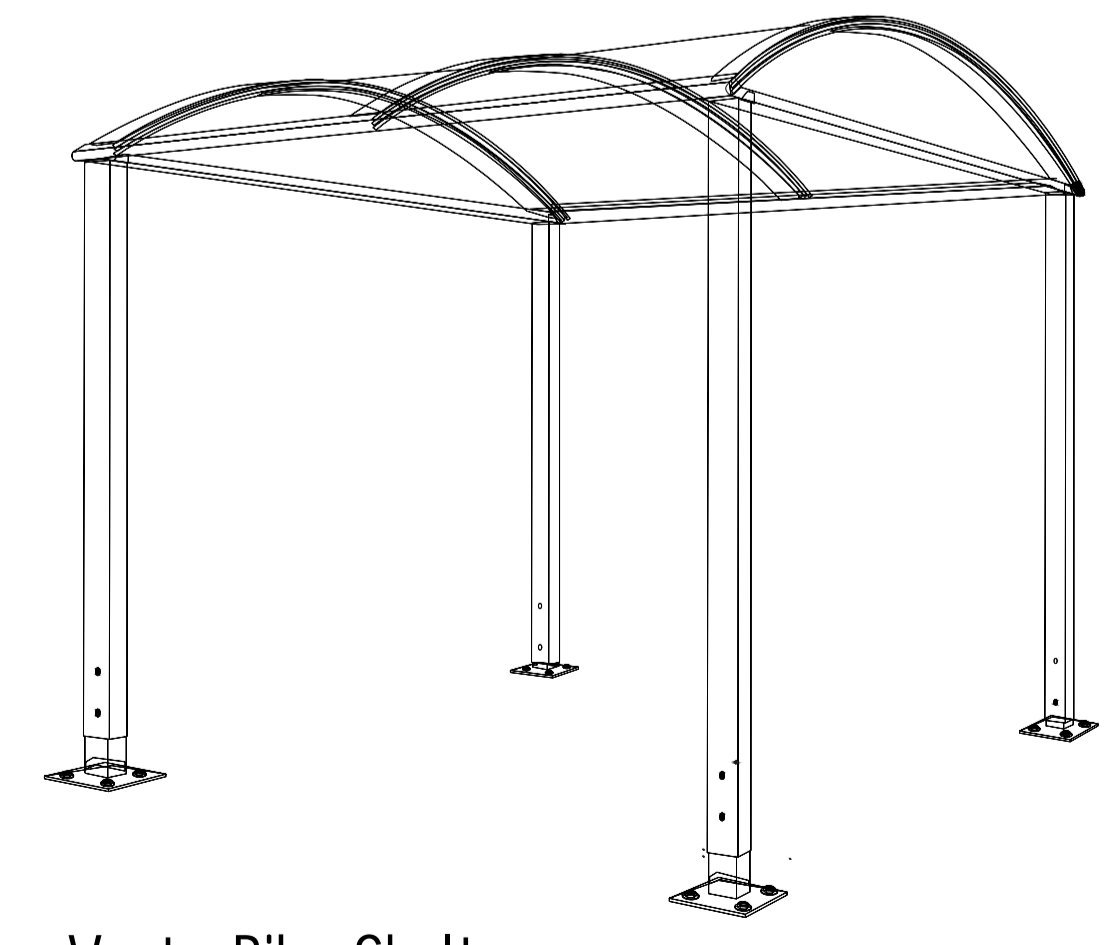

Voute Bike Shelter

